

SERIE 250

COMFORT AND DESIGN

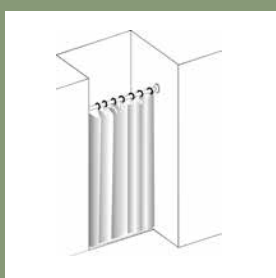

INDICE SERIE 250
INHALT SERIE 250
INDEX SERIE 250
INDICE SERIE 250

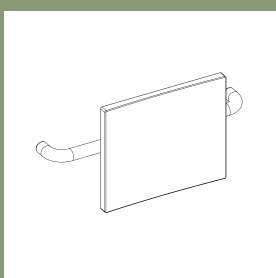
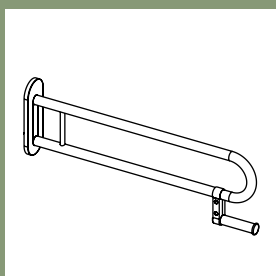
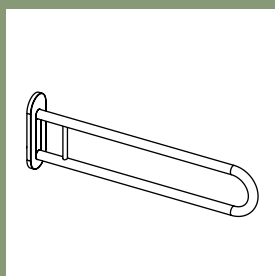
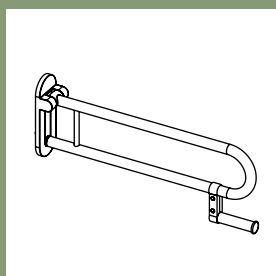
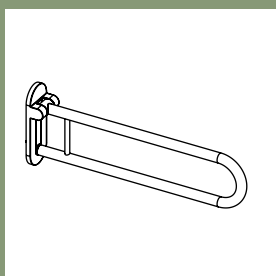
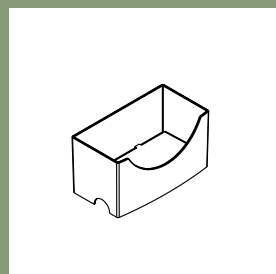
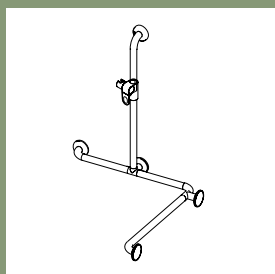
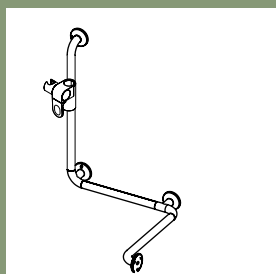
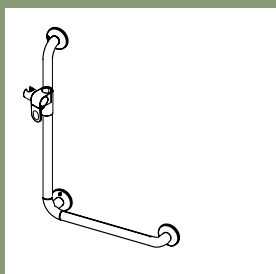
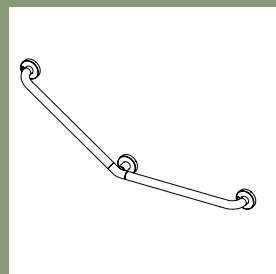
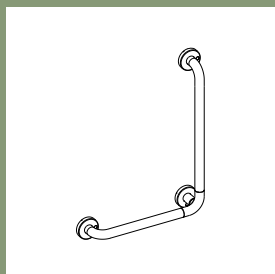
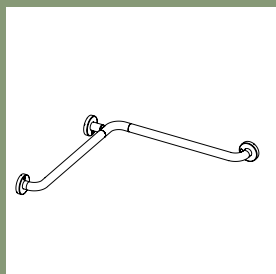
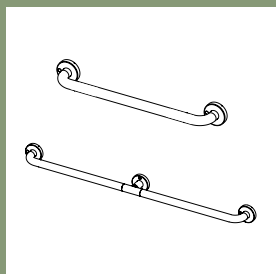



SERIE 250 - SISTEMA DI MANIGLIONI

Caratteristiche ideali di pulizia grazie alla forma liscia, materiali di alta qualità, un sistema di costruzione modulare per la preparazione di misure speciali e un design moderno e chiaro, sono le eccezionali caratteristiche del sistema di maniglioni Serie 250. L'intero sistema è testato TÜV con una capacità portante tra 120 e 130 kg secondo la guida di riferimento per dispositivi medici CE EWG 93/42. Il sistema è prodotto in alluminio rivestito a polvere PRO SENSE® con copertura delle rosette resistenti UV. Questo programma si completa con il maniglione ribaltabile e di sostegno con/senza portarotolo e su richiesta con una scelta di diverse variazioni di colori RAL, da impiegare sia nel settore privato che nel pubblico, privo di barriere.

SERIE 250 - GRIFFSYSTEM

Ideale Reinigungseigenschaften durch die fast rillenlose Formgebung als G-Stock-Prinzip, hochwertige Materialien, modulares Baukastensystem für die Ausarbeitung von Sondermaßen und modernes, klares Design sind die herausragenden Merkmale des Griffsystems der Serie 250. Das gesamte System ist mit einer Belastbarkeit zwischen 120 und 130 kg laut TÜV getestet und entspricht den Richtlinien für Medizinprodukte CE EWG 93/42. Das System besteht aus pulverbeschichtetem Aluminium PRO SENSE® und UV-beständigen Rosettenabdeckungen. Komplettiert wird dieses Programm durch den Klapp- und Stützgriff mit/ohne Papierrollenhalter und auf Anfrage einer Auswahl von verschiedenen RAL-Farbvarianten, die sowohl im privaten, als auch öffentlichem barrierefreien Sanitärbereich zum Einsatz kommen.

SERIE 250 - GRAB BAR SYSTEM

Ideal cleaning characteristics through the smooth styling, high-quality materials, modular construction system for the elaboration of special measures and modern, clear Design are the outstanding characteristics of the handle system of the series 250. The entire system is tested with a maximum load-bearing capacity between 120 and 130 kg according to TÜV and corresponds to the guidelines for medicine products CE EEC 93/42. The system consists of powder-coated aluminium PRO SENSE® and UV resistant rosette covers. This program is completed by the folding and support handle with/without paperholder and on request a selection of different RAL color variants, which are used in the private as well as in the public barrier-free sanitary area.

SERIE 250 - SISTEMA DE ASIDEROS

Características ideales de limpieza por la forma modular, materiales de alta calidad, sistema modular de construcción para la elaboración de medidas especiales y el diseño moderno y claro, son las características excepcionales del sistema de asideros de la serie 250. El sistema entero se prueba con una capacidad portadora máxima entre 120 y 130 kilogramos según certificado TÜV y corresponde a las pautas para EEC 93/42 del CE de los productos para medicina. El sistema consiste en aluminio polvo-revestido PRO SENSE® y es resistente a UV el rosetón. Este programa es completado con el asidero móvil y el asidero de apoyo si/no con el sostenedor de papel y a consultar una selección de diversas variantes de color RAL, que se utilizan tanto en el uso particular como en el área sanitaria pública con todas las normativas.

SERIE 250 HG

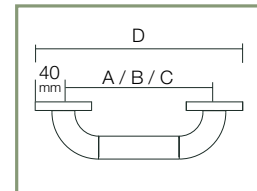

	RAL 9010
Bianco Weiß White Blanco	31

	RAL 1023
Giallo Gelb Yellow Amarillo	12*

	RAL 3003
Rosso Rot Red Rojo	13*

	RAL 5011
Blu Blau Blue Azul	14*

	RAL 7037
Grigio Grau Grey Gris	08*

	Bianco/Grigio Weiß/Grau White/Grey Blanco/Gris
	38

Descrizione articolo Artikelbezeichnung Model description Descripción artículo	Articolo Artikel Model Código	Misure Maße Sizes Medidas mm			
		A	B	C	D
<p>Maniglione Wandhaltegriff Holding handle Asidero fijo</p>	2020 HG 31 PM	250			330
	2021 HG 31 PM	300			380
	2022 HG 31 PM	400			480
	2023 HG 31 PM	500			580
	2024 HG 31 PM	600			680
	2025 HG 31 PM	700			780
	2026 HG 31 PM	800			880
<p>Corrimano a parete Wandhandlauf Wall handrail Barra de seguridad de pared</p>	2030 HG 31 PM	1050			1130
	2031 HG 31 PM	1150			1230
	2032 HG 31 PM	1250			1330
<p>Maniglione 145° reversibile Wandhaltegriff 145° reversibel Wall handle 145° reversible Asidero fijo 145° reversible</p>	2040 HG 31 PM	425	325		
	2041 HG 31 PM	625	425		
<p>Maniglione 90° reversibile Wandhaltegriff 90° reversibel Wall handle 90° reversible Asidero fijo 90° reversible</p>	2050 HG 31 PM	600	350		
	2051 HG 31 PM	600	450		
	2052 HG 31 PM	800	600		
<p>Sostegno angolare con supporto verticale Wandhaltegriff mit Senkrechtstütze Holding handle with vertical support Asidero fijo de pared con soporte vertical</p>	2060 HG 31 PM	650	570	540	
<p>Corrimano singolo per doccia Duschhandlauf einfach Single shower handrail Barra de seguridad simple</p>	2070 HG 31 PM	725	755		
	2072 HG 31 PM	905	1075		
<p>Corrimano doppio per doccia Duschhandlauf doppelt Double shower handrail Barra de seguridad doble</p>	2080 HG 31 PM	755	1180		
	2081 HG 31 PM	905	1180		
<p>Saliscendi sciolto Brausehalter lose Shower holder loose Soporte para ducha suelto</p>	0004 BR 38 PM	Abbinabile a tutti i maniglioni - colore bianco Passend für alle Griffe - Farbe weiß Suitable for all handles - colour white Adaptable para todo asideros - blanco			

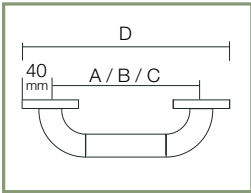

	RAL 9010
Grigio Grau Grey Gris	Bianco Weiß White Blanco
17	31

	RAL 1023	RAL 3003	RAL 5011	RAL 7037
Giallo Gelb Yellow Amarillo	Rosso Rot Red Rojo	Blu Blau Blue Azul	Grigio Grau Grey Gris	
12*	13*	14*	08*	

Descrizione articolo Artikelbezeichnung Model description Descripción artículo	Articolo Artikel Model Código	Misure Maße Sizes Medidas mm			
		A	B	C	D
<p>Sostegno per doccia con saliscendi Haltegriff vertikal mit Brausehalter Holding handle with shower holder Soporte para brazo de ducha</p>	2090 HG 31 PM	600			680
	2091 HG 31 PM	800			880
	2092 HG 31 PM	1000			1080
<p>Sostegno per doccia a 90° con saliscendi Haltegriff 90° mit Brausehalter Holding handle 90° with shower holder Soporte para brazo de ducha 90°</p>	2100 HG 31 PM	1000	450		
	2101 HG 31 PM	1190	450		
	2102 HG 31 PM	1190	650		
<p>Sostegno angolare con saliscendi Duschhandlauf mit Brausehalter Wall handrail with shower holder Asidero fijo de pared con soporte para brazo de ducha</p>	2110 HG 31 PM	1000	570	725	
	2111 HG 31 PM	1190	710	725	
<p>Sostegno angolo a T con saliscendi Duschhandlauf Ecke T-Form mit Brausehalter Handrail corner T-form with shower holder Barra de seguridad córner y T con brazo de ducha</p>	2120 HG 31 PM	1135	325	545	725
	2121 HG 31 PM	1135	525	685	725
	2122 HG 31 PM	1135	525	685	875
<p>Corrimano a T con saliscendi Handlauf T-Form mit Brausehalter Handrail T-form with shower holder Barra de seguridad T con brazo de ducha</p>	2130 HG 31 PM	1135	425	525	
<p>Mensola per maniglioni Ablage für Griffe Shelf for grab bars Estante para soporte</p>	0080 ZH 17 PM	107	205	110	
	0080 ZH 31 PM	107	205	110	
<p>Saliscendi sciolto Brausehalter lose Shower holder loose Soporte para ducha suelto</p> <p>Standard</p>	2001 BR 31 PM	Abbinabile a tutti i maniglioni - colore bianco Passend für alle Griffe - Farbe weiß Suitable for all handles - colour white Adaptable para todo asideros - blanco			

SERIE 250 HG



	RAL 9010	RAL 1023	RAL 3003	RAL 5011	RAL 7037	
	Bianco Weiß White Blanco	Giallo Gelb Yellow Amarillo	Rosso Rot Red Rojo	Blu Blau Blue Azul	Grigio Grau Grey Gris	Grigio/Bianco Grau/Weiß Grey/White Gris/Blanco
	31	12*	13*	14*	08*	37

Descrizione articolo Artikelbezeichnung Model description Descripción artículo	Articolo Artikel Model Código	Misure Maße Sizes Medidas mm				
		A	B	C		
Appoggio ribaltabile Klappgriff Folding handle Asidero móvil	2001 HG 31 PM	650	280	100		
	2002 HG 31 PM	750	280	100		
	2003 HG 31 PM	850	280	100		
Appoggio ribaltabile con portarotolo Klappgriff mit Papierrollenhalter Folding handle with paper holder Asidero móvil con portarrollos	2201 HG 31 PM	650	280	100		
	2202 HG 31 PM	750	280	100		
	2203 HG 31 PM	850	280	100		
Portarotolo di riserva Reserve Papierrollenhalter Additional paper holder Citapa de reserva	0262 BG 31 PM	115	150			
Tenda Duschvorhang Shower curtain Cortina ducha	0050 VH 31 PM	850	640-850			
Schienale per WC con maniglione Rückenlehne für WC mit Haltegriff Backrest for WC with handle Respaldo para WC con asidero	2090 ZH 37 PM	355	300	550	582	
Schienale per WC Rückenlehne für WC Backrest for WC Respaldo para WC	2095 ZH 37 PM	355	300	80		

* Colore speciali su richiesta | Sonderfarben auf Anfrage | Special colours on request | Colores especiales a pedido

SERIE 250 HG

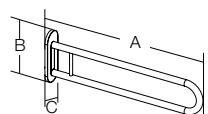
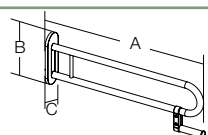
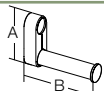
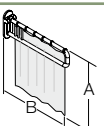

	RAL 9010	RAL 1023	RAL 3003	RAL 5011	RAL 7037
	Bianco Weiß White Blanco	Giallo Gelb Yellow Amarillo	Rosso Rot Red Rojo	Blu Blau Blue Azul	Grigio Grau Grey Gris
	31	12*	13*	14*	08*

Descrizione articolo Artikelbezeichnung Model description Descripción artículo	Articolo Artikel Model Código	Misure Maße Sizes Medidas mm					
		A	B	C			
 Maniglione di sostegno Stützgriff Support handle Asidero de apoyo	2011 HG 31 PM	650	280	100			
	2012 HG 31 PM	750	280	100			
	2013 HG 31 PM	850	280	100			
 Maniglione di sostegno con portarotolo Stützgriff mit Papierrollenhalter Support handle with paper holder Asidero de apoyo con portarollos	2211 HG 31 PM	650	280	100			
	2212 HG 31 PM	750	280	100			
	2213 HG 31 PM	850	280	100			
 Portarotolo di riserva Reserve Papierrollenhalter Additional paper holder Citapa de reserva	0262 BG 31 PM	115	150				
 Tenda Duschvorhang Shower curtain Cortina ducha	0050 VH 31 PM	850	640-850				

Il maniglione ribaltabile e di sostegno sono in alluminio anodizzato di alta qualità ed sono stati sviluppati in collaborazione con lo studio Talocci Design e sono la simbiosi perfetta tra design moderno e tecnica sicura. L'uso di raggi appropriati, la possibilità d'arretramento in ogni posizione e l'assenza di spigoli pericolosi, garantiscono un uso sicuro e delle buone caratteristiche di manutenzione.

Der Stütz- und Klappgriff besteht aus hochwertigem, pulverbeschichtetem Aluminium und wurden in Zusammenarbeit mit dem Designstudio Talocci Design und sind die perfekte Symbiose aus modernem Design und sicherer Technik. Der Einsatz geeigneter Radien, die Möglichkeit der Arretierung in jeder Position und die Vermeidung von Stoßkanten gewährleisten eine sichere Benutzung und gute Pflegeeigenschaften.

The folding and support handle consists of high quality, powder coated aluminium and were developed in co-operation with Design studio Talocci and are a perfect symbiosis between modern design and secure technology. The suitable radius, the possible locking mechanism in each position and curved edges ensure safe and easy use.

El asidero de apoyo y móvil está fabricado en aluminio anodizado y fue desarrollado en cooperación con el estudio Talocci Design y son una simbiosis perfecta entre el diseño moderno y tecnología segura. El radio apropiado, el mecanismo de bloqueo posible en cada posición y la ausencia de esquinas peligrosas, garantizan un uso seguro y un buen mantenimiento.

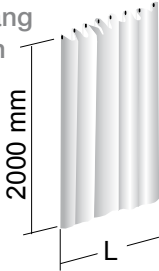
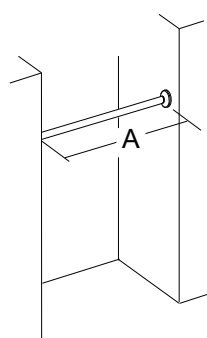
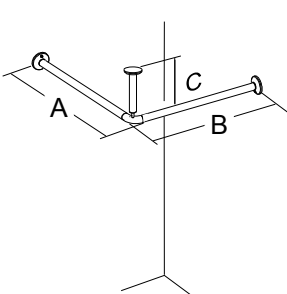
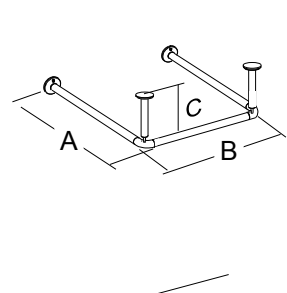

SERIE 250 VH + VN + VE + VU

TUBO CON TENDA DOCCIA
 DUSCHSTANGE MIT VORHANG
 TUBE WITH SHOWER CURTAIN
 BARRA CON CORTINA DE DUCHA

		Tende consigliate Passender Duschvorhang Suitable shower curtain Cortina aconsejable								
				0007 VH 31 PM L = 1200 mm	0010 VH 31 PM L = 1500 mm	0013 VH 31 PM L = 1800 mm	0019 VH 31 PM L = 2400 mm	0025 VH 31 PM L = 3000 mm	0031 VH 31 PM L = 3600 mm	
Articolo Artikel Model Código										
Nicchia - Nische - Niche - Huecos		0004 VN 31 PM A = 900 mm Anelli - Ringe - hooks - aillas 8	1x							
		0005 VN 31 PM A = 1000 mm Anelli - Ringe - hooks - aillas 10		1x						
		0007 VN 31 PM A = 1200 mm Anelli - Ringe - hooks - aillas 10		1x						
		0010 VN 31 PM A = 1500 mm Anelli - Ringe - hooks - aillas 12			1x					
Angolo - Ecke - Corner - Angular	 C = 585 mm	0004 VE 31 PM A = 900 mm B = 900 mm Anelli - Ringe - hooks - aillas 16				1x				
		0005 VE 31 PM A = 1000 mm B = 1000 mm Anelli - Ringe - hooks - aillas 16				1x				
		0007 VE 31 PM A = 1200 mm B = 1200 mm Anelli - Ringe - hooks - aillas 20					1x			
		0010 VE 31 PM A = 1500 mm B = 1500 mm Anelli - Ringe - hooks - aillas 24						1x		
A "U" / "U"-Form / "U"-form / En "U"	 C = 585 mm	0004 VU 31 PM A = 900 mm B = 900 mm Anelli - Ringe - hooks - aillas 8 + 16	1x			1x				
		0005 VU 31 PM A = 1000 mm B = 1000 mm Anelli - Ringe - hooks - aillas 10 + 16		1x		1x				
		0007 VU 31 PM A = 1200 mm B = 1200 mm Anelli - Ringe - hooks - aillas 10 + 20		1x			1x			
		0010 VU 31 PM A = 1500 mm B = 1500 mm Anelli - Ringe - hooks - aillas 12 + 24			1x			1x		

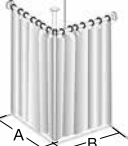

	RAL 9010
	Bianco Weiß White Blanco
	31

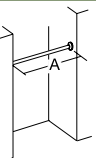
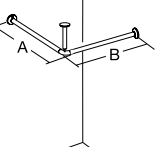
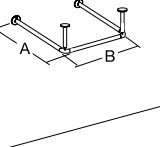
Descrizione articolo Artikelbezeichnung Model description Descripción artículo	Articolo Artikel Model Código	Misura piatto doccia Tassenmaß Tray size Medidas del plato mm		
		A	B	
 <p>Tenda nicchia Duschvorhang Nische Shower curtain niche Cortina ducha forma de cavidad</p>	0007 VH 31 PM	900		
	0010 VH 31 PM	1000		
	0010 VH 31 PM	1200		
	0013 VH 31 PM	1500		
 <p>Tenda angolo Duschvorhang Ecke Shower curtain corner Cortina ducha angular</p>	0019 VH 31 PM	900	900	
	0019 VH 31 PM	1000	1000	
	0025 VH 31 PM	1200	1200	
	0031 VH 31 PM	1500	1500	
 <p>Tenda a "U" Duschvorhang "U"-Form Shower curtain "U"-form Cortina ducha en forma "U"</p>	0007 VH 31 PM + 0019 VH 31 PM	900	900	
	0010 VH 31 PM + 0019 VH 31 PM	1000	1000	
	0010 VH 31 PM + 0025 VH 31 PM	1200	1200	
	0013 VH 31 PM + 0031 VH 31 PM	1500	1500	
 <p>Tubo reggitenda nicchia Duschstange Nische Shower curtain tube niche Barra cortina ducha forma de cavidad</p>	0004 VN 31 PM	900		
	0005 VN 31 PM	1000		
	0007 VN 31 PM	1200		
	0010 VN 31 PM	1500		
 <p>Tubo reggitenda angolo Duschstange Ecke Shower curtain tube corner Barra ducha angular</p>	0004 VE 31 PM	900	900	
	0005 VE 31 PM	1000	1000	
	0007 VE 31 PM	1200	1200	
	0010 VE 31 PM	1500	1500	
 <p>Tubo reggitenda a "U" Duschstange "U"-Form Shower curtain tube "U"-form Barra ducha en forma "U"</p>	0004 VU 31 PM	900	900	
	0005 VU 31 PM	1000	1000	
	0007 VU 31 PM	1200	1200	
	0010 VU 31 PM	1500	1500	